

Montage/Anschluss  
 Montage/Raccordement  
 Mounting/Connection

# A121

Montageanweisung\_A121.pdf

19.04.2010



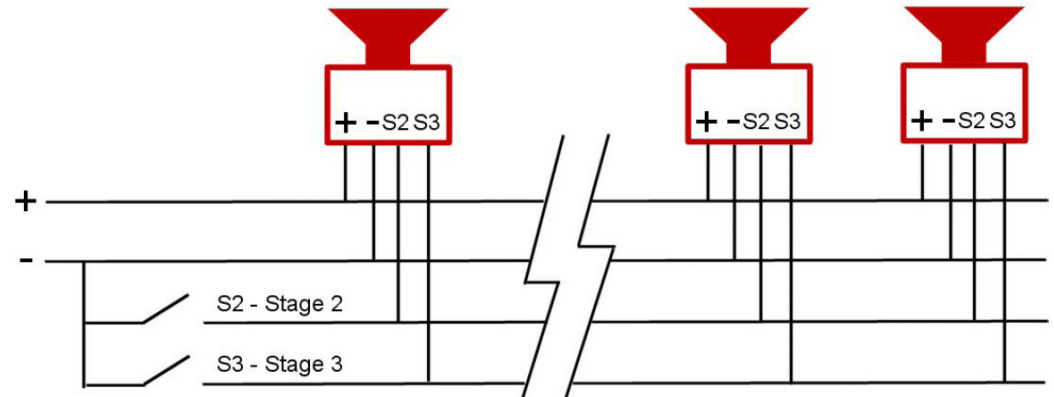
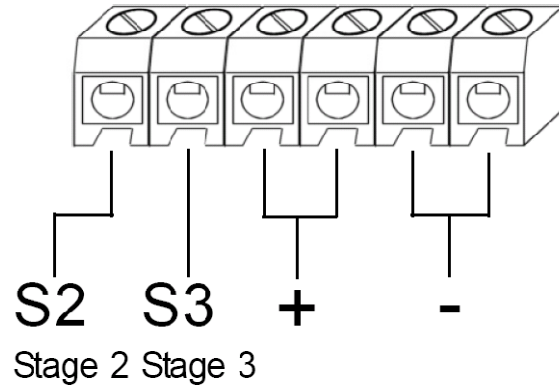



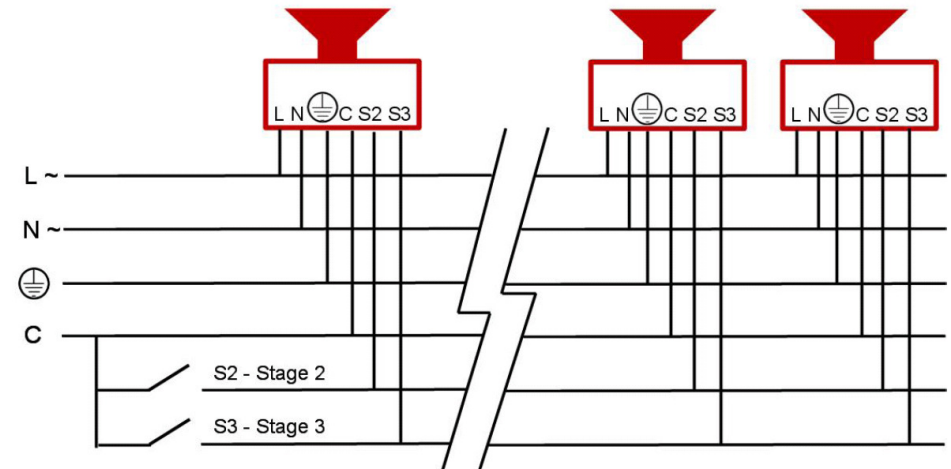
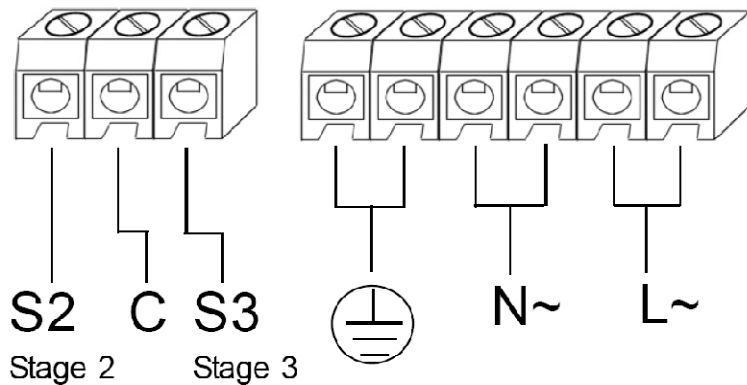







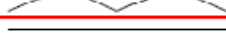



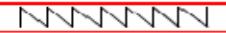



















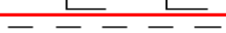





## 24, 48V DC



## 115, 230 VAC



**Lebensgefahr durch elektrischen Strom!** Dieses Gerät darf nur durch autorisierte Elektrofachkräfte und elektrotechnisch unterwiesene Personen montiert und angeschlossen werden.  
**Electric current! Danger to life!** Only authorized or instructed persons may assemble and install this device.  
**Tension électrique dangereuse!** Seuls les personnes averties sont autorisées d'assembler et d'installer ces produits.

Stage 1	Frequency Description	A121 dB @ 1m		Switch						Stage 2 (S2)	Stage 3 (S3)
				1	2	3	4	5	6		
Tone 1	340 Hz Continuous	113dB(A) @ 1m								Tone 2	Tone 5
Tone 2	800/1000Hz @ 0.25 sec Alternating	121dB(A) @ 1m		■						Tone 17	Tone 5
Tone 3	500/1200Hz @ 0.3Hz 0.5 sec Slow Whoop	121dB(A) @ 1m		■	■					Tone 2	Tone 5
Tone 4	000/1000Hz @ 1Hz Sweeping	121dB(A) @ 1m		■	■					Tone 6	Tone 5
Tone 5	2400Hz Continuous	125dB(A) @ 1m				■				Tone 3	Tone 20
Tone 6	2400/2900Hz @ 7Hz Sweeping	123dB(A) @ 1m		■	■					Tone 7	Tone 5
Tone 7	2400/2900Hz @ 1Hz Sweeping	125dB(A) @ 1m		■	■					Tone 10	Tone 5
Tone 8	500/1200/500Hz @ 0.3Hz Sweeping	121dB(A) @ 1m		■	■					Tone 2	Tone 5
Tone 9	1200/500Hz @ 1Hz - DIN / PFEER P. I.A.P.	121dB(A) @ 1m					■			Tone 15	Tone 2
Tone 10	2400/2900Hz @ 7Hz Alternating	126dB(A) @ 1m		■			■			Tone 7	Tone 5
Tone 11	1000Hz @ 1Hz Intermittent	121dB(A) @ 1m			■		■			Tone 2	Tone 5
Tone 12	800/1000Hz @ 0.875Hz Alternating	121dB(A) @ 1m		■	■					Tone 4	Tone 5
Tone 13	2400Hz @ 1Hz Intermittent	125dB(A) @ 1m			■		■			Tone 15	Tone 5
Tone 14	800Hz 0.25sec on, 1 sec off Intermittent	120dB(A) @ 1m		■	■		■			Tone 4	Tone 5
Tone 15	000Hz Continuous	120dB(A) @ 1m			■		■			Tone 2	Tone 5
Tone 16	660Hz 150mS on, 150mS off Intermittent	118dB(A) @ 1m		■	■		■			Tone 18	Tone 5
Tone 17	544Hz (100mS)/440Hz (400mS) NF S 32 001	117dB(A) @ 1m						■		Tone 2	Tone 27
Tone 18	660Hz 1.8sec on, 1.8sec off Intermittent	118dB(A) @ 1m		■				■		Tone 2	Tone 5
Tone 19	1.4KHz-1.6KHz 1s, 1.6KHz-1.4KHz 0.5s -NFC48-265	126dB(A) @ 1m			■			■		Tone 2	Tone 5
Tone 20	660Hz Continuous	118dB(A) @ 1m		■	■			■		Tone 2	Tone 5
Tone 21	554Hz/440Hz @ 1Hz Alternating	118dB(A) @ 1m				■		■		Tone 2	Tone 5
Tone 22	544Hz @ 0.875 sec. Intermittent	118dB(A) @ 1m		■				■		Tone 2	Tone 5
Tone 23	800Hz @ 2Hz Intermittent	120dB(A) @ 1m			■		■			Tone 6	Tone 5
Tone 24	800/1000Hz @ 50Hz Sweeping	120dB(A) @ 1m		■	■			■		Tone 29	Tone 5
Tone 25	2400/2900Hz @ 50Hz Sweeping	124dB(A) @ 1m					■	■		Tone 29	Tone 5
Tone 26	Bell	118dB(A) @ 1m		■				■		Tone 2	Tone 15
Tone 27	554Hz Continuous	117dB(A) @ 1m			■		■			Tone 26	Tone 5
Tone 28	440Hz Continuous	117dB(A) @ 1m		■	■			■		Tone 2	Tone 5
Tone 29	800/1000Hz @ 7Hz Sweeping	121dB(A) @ 1m				■		■		Tone 7	Tone 5
Tone 30	300Hz Continuous	114dB(A) @ 1m		■	■			■		Tone 2	Tone 5
Tone 31	660/1200Hz @ 1Hz Sweeping	121dB(A) @ 1m			■		■			Tone 26	Tone 5
Tone 32	Two tone chime.	118dB(A) @ 1m		■	■			■		Tone 26	Tone 15
Tone 33	745Hz @ 1Hz Intermittent	116dB(A) @ 1m							■	Tone 2	Tone 5
Tone 34	1000 & 2000Hz @ 0.5 sec Alternating - Singapore	121dB(A) @ 1m		■				■		Tone 38	Tone 45
Tone 35	420Hz @ 0.525 sec Australian Alert	118dB(A) @ 1m							■	Tone 35	Tone 5
Tone 36	500-1200Hz 3.75sec / 0.25sec Australian Evac	121dB(A) @ 1m		■	■			■		Tone 35	Tone 5
Tone 37	1000Hz Continuous - PFEER Toxic Gas	121dB(A) @ 1m					■		■	Tone 9	Tone 45
Tone 38	2000Hz Continuous	122dB(A) @ 1m		■				■		Tone 34	Tone 45
Tone 39	800Hz 0.25sec on, 1 sec off Intermittent	120dB(A) @ 1m		■	■			■		Tone 23	Tone 17
Tone 40	544Hz (100mS)/440Hz (400mS) - NF S 32-001	121dB(A) @ 1m		■	■			■		Tone 31	Tone 27
Tone 41	Motor Siren - slow rise to 1200 Hz	122dB(A) @ 1m					■		■	Tone 2	Tone 5
Tone 42	Motor Siren - slow rise to 800 Hz	121dB(A) @ 1m		■				■		Tone 2	Tone 5
Tone 43	1200 Hz Continuous	122dB(A) @ 1m			■			■		Tone 2	Tone 5
Tone 44	Motor Siren - slow rise to 2400 Hz	124dB(A) @ 1m		■	■			■		Tone 2	Tone 5
Tone 45	1KHz 1s on, 1s off Intermittent - PFEER Gen. Alarm	121dB(A) @ 1m					■		■	Tone 38	Tone 34