

SYWA

EN54-23 Fire Alarm Devices
Visual Alarm Device for use
in & around buildings

Dispositifs incendie EN54-23
Dispositifs visuels Alarme Feu pour
utilisation à l'intérieur et autour
des bâtiments

EN54-23 Feuermeldevorrichtung
Optischer Signalgeber zur Innen-
und Aussenmontage



0333
0333-CPD-075445
0333-CPD-075446

	9-60VDC	
	1.5W (max)	
	2.4m (max)	
	High Power 1 Hz 0.5Hz	Low Power 1 Hz 0.5Hz
	W-2.4-7.5 7.5m (135m³)	W-2.4-2.5 2.5m (15m³)
	White Flash Flash blanc Weisser Blitz	12V 51mA 27mA 35mA 19mA 24V 25mA 16mA 16mA 10mA 48V 18mA 11mA 11mA 9mA
	Red Flash Flash rouge Roter Blitz	12V 51mA 27mA 35mA 19mA 24V 25mA 16mA 16mA 10mA 48V 18mA 11mA 11mA 9mA
	< 120% for 10mS	
	100mS ON / 900mS OFF 50mS ON / 950mS OFF	
	0.5mm² - 2.5mm²	
	-25°C ~ 70°C	
	FR ABS & Polycarbonate	
	Type A S IP21C	Type B WP IP66

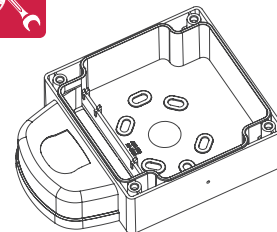
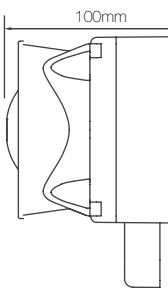
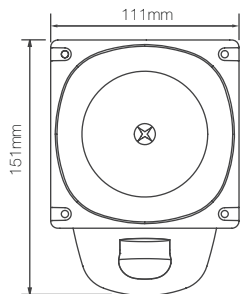
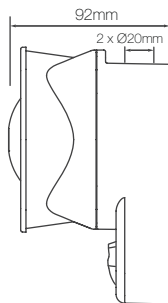
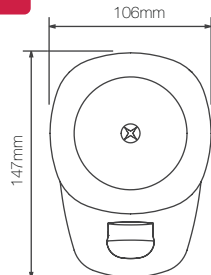

- Drilling diameter must be adjusted to the diameter of the cable.
- Le diamètre de perçage doit être adapté au diamètre des câbles.
- Drilling diameter must be adjusted to the diameter of the cable.

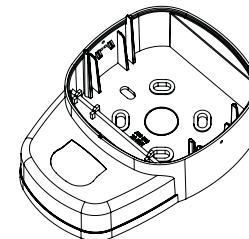
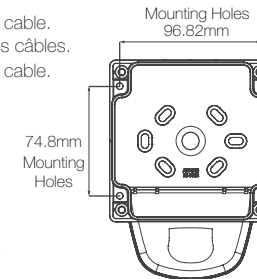
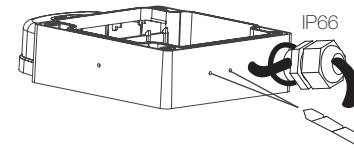

- Cable Glands must be compatible with declared cable size.
- Les presses-étoupes doivent être adaptés à la section des câbles déclarée
- Kabeldurchführungen muessen mit den angegebenen Kabelabmessungen kompatibel sein

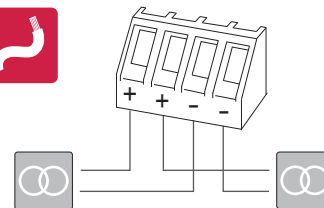
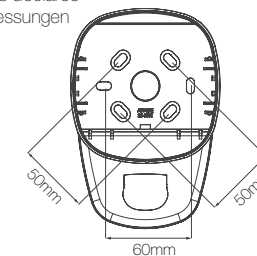
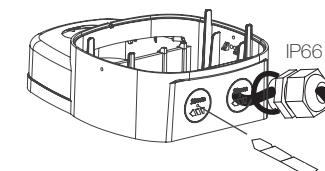

	ON		
1	1	2	3
0	1	0	
	1Hz	1	Pass
	0.5Hz	0	Pass
	High Power	1	Pass
	Low Power	0	Pass
	White		N/A



Wall Mounted: W-2.4-7.5

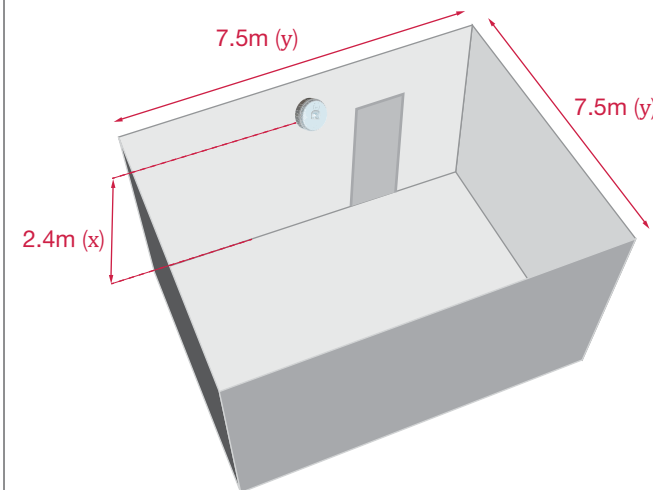

25-11204-D